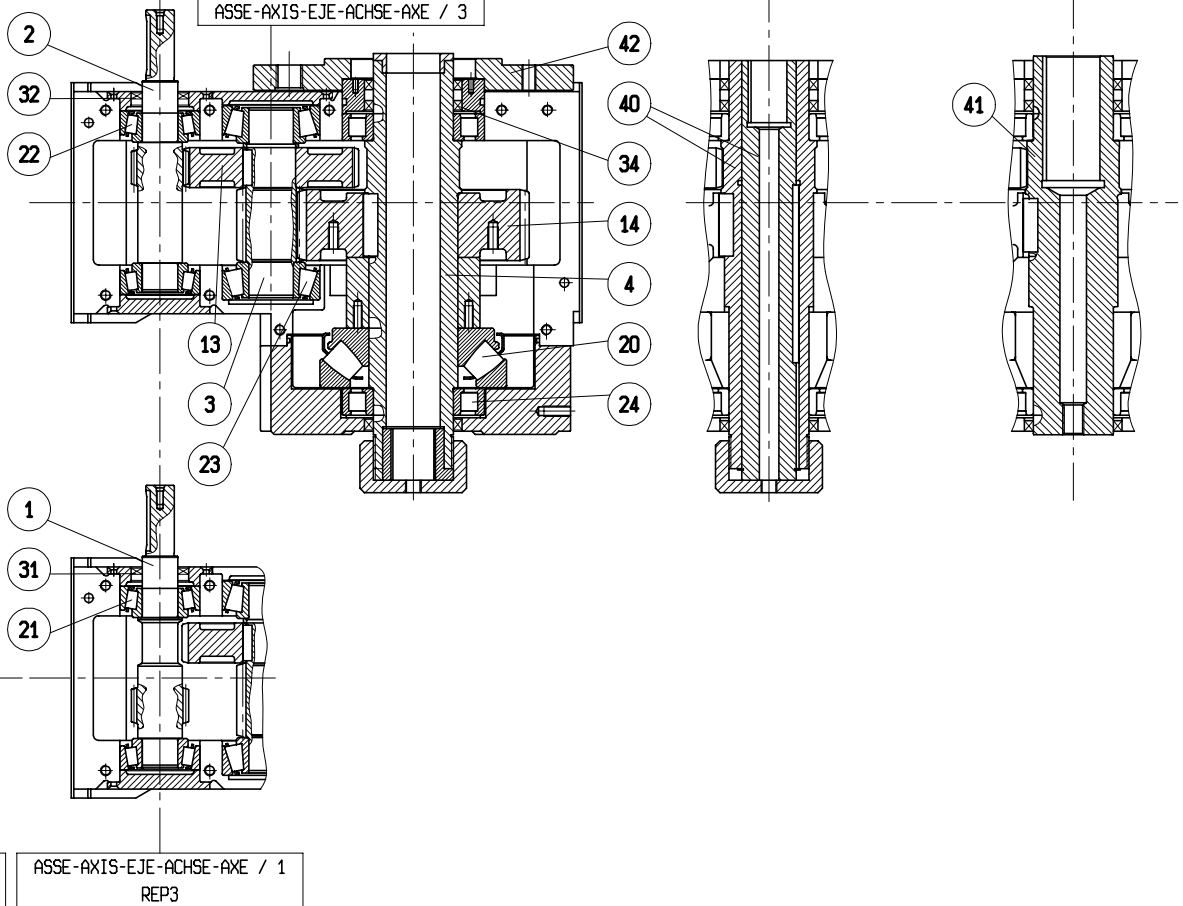

ASSE-AXIS-EJE-ACHSE-AXE / 2
REP2ASSE-AXIS-EJE-ACHSE-AXE / 4
EPPASSE-AXIS-EJE-ACHSE-AXE / 4
EPAASSE-AXIS-EJE-ACHSE-AXE / 4
EAA

CUSCINETTO / BEARING / RODAMIENTO / ACHSLAGER / ROULEMENT

POS	Q.TY	R	125	140	160	180	200	225	250	280	315	355
24	2	REP2/REP3	NJ214EC	NJ216EC	NJ218EC	NJ220EC	NJ224EC	NJ228EC	NCF2934U	23938	23944	23948
23	2	REP2/REP3	33208	32309	32310	32311	32312	32313	32315	32317	32319	22322
22	2	REP2	33207	33208	33210	33211	33212	33213	33215	33216	33218	33220
	1	REP2	in>-20	in>-20	in>-18	in>-18	in>-20	in>-20	in>-22.5	in>-22.5	in>-22.5	
	1		33207	33208	33208	33211	33212	33213	33215	33216	33218	
2	REP3	33206	33207	33208	33209	33210	32311	33312	32313	32315	32317	
21	2	REP3	32306	32307	32308	32309	32310	32311	32312	32313	32315	32317
20	1	REP2/REP3	min 29414	min 29416	min 29418	min 29420	min 29424	min 29426	min 29434	min 29438	min 29444	min 29448
			max 29418	max 29422	max 29426	max 29428	max 29418	max 29434	max 29440	max 29448	max 29456	max 29464

COMPONENTI/COMPONENTS/ELEMENTOS/KOMPONENTEN/PIECES

POS	Q.TY	R	125	140	160	180	200	225	250	280	315	355
42	1											
41	1											
40	1											
14	1											
13	1											
4	1											
3	1											
2	1											
1	1											

ANELLO DI TENUTA / SEAL RING / RETEN / DICHTUNGSRING / BAGUE D'ETANCHEITE DIN 3760

POS	Q.TY	R	125	140	160	180	200	225	250	280	315	355
34	3	REP	70x90x10	80x100x7	90x110x12	100x120x12	120x150x12	130x160x12	170x200x15	190x220x15	220x250x15	240x270x15
32	1(2)	REP2	35x45x7	40x55x8	50x65x8	55x72x8	60x75x8	65x85x10	75x95x10	80x100x7	90x110x12	100x120x10
31	1(2)	REP3	30x45x8	35x55x8	45x65x10	45x72x8	50x75x10	55x85x10	60x95x10	65x100x10	75x110x12	85x120x12